

Vernis Shape
Single lever bath mixer for exposed installation
 Finish: **Matt Black** Article Number: **71450670**



Description

product features

- 2 functions
- projection: 166 mm
- centre distance: 150 ± 12 mm
- spray type mixer: normal spray
- maximum flow rate at 3 bar: 22,5 l/min
- flow rate for bath spout at 3 bar: 22,5 l/min
- flow rate of hand shower at 3 bar: 15,7 l/min
- ceramic cartridge
- temperature limitation adjustable
- diverter with automatic resetting
- with silencer
- suitable for continuous flow water heaters
- connection dimension: DN15
- connection type: s-shaped connections
- wall-mounted
- min. operating pressure: 1 bar
- max. operating pressure: 10 bar

Technology



Product image



Scale drawing

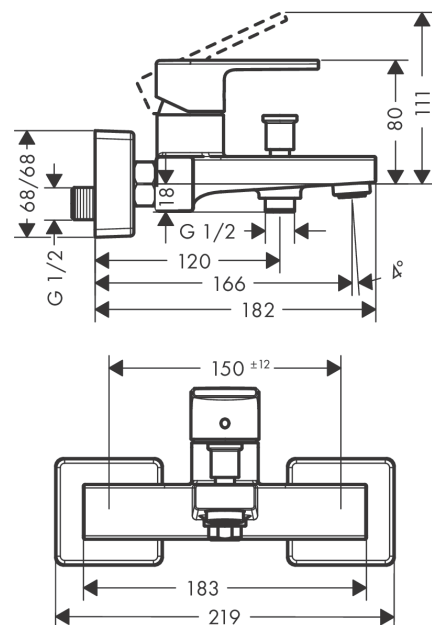

Vernis Shape
Single lever bath mixer for exposed installation
 Finish: **Matt Black** Article Number: **71450670**



Flowchart

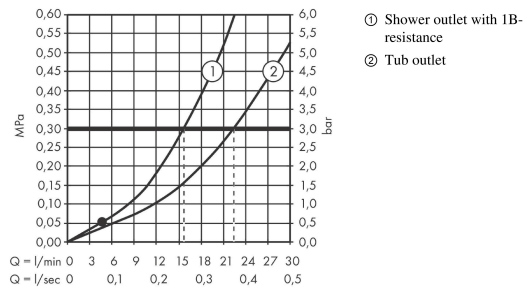

Vernis Shape
Single lever bath mixer for exposed installation
 Finish: **Matt Black** Article Number: **71450670**



Exploded Drawing

Year of production: >04/21

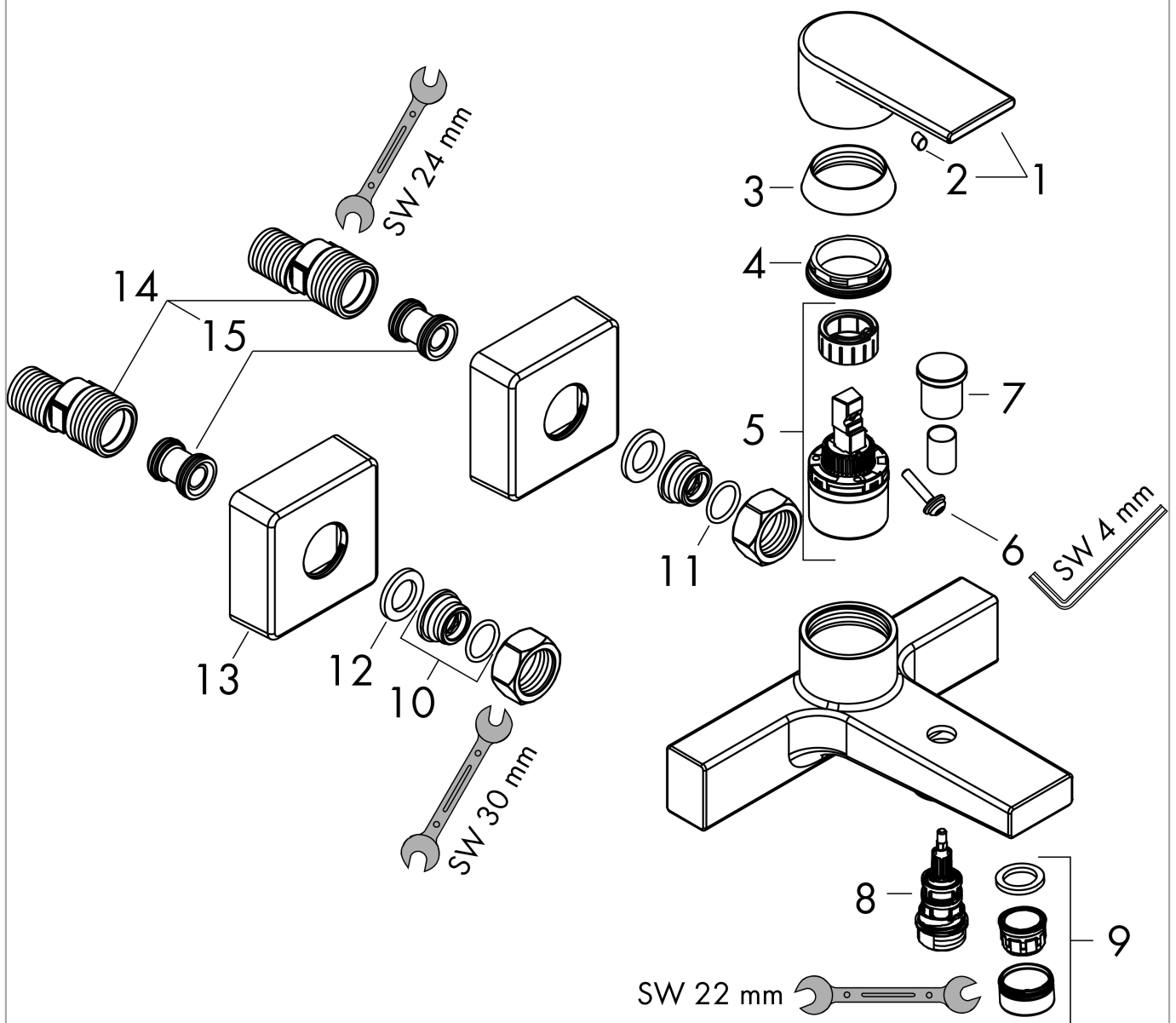

Vernis Shape
Single lever bath mixer for exposed installation
 Finish: **Matt Black** Article Number: **71450670**



Spare part list

Year of production: >04/21

Pos.	Description	Article Number	PC	PU
1	handle	93719670	59	1
2	screw cover	96338000	1	1
3	flange	93716670	52	1
4	nut	93717000	4	1
5	cartridge, assy	92730000	11	1
6	locking screw for handle	95140000	2	1
7	diverter knob	93766670	55	1
8	selector	97978000	11	1
9	aerator M24x1 (38 l/min)	92513670	54	1
10	connecting thread G½	93767000	3	1
11	O-ring 16x2	98133000	1	1
12	filter packing	96922000	3	1
13	escutcheon	93879670	55	1
14	set of S-unions (±12 mm)	94140000	10	1
15	noise reduction	96429000	2	1